

# HFW/EC

Varmförzinkade cirkulära axialfläktar med EC-teknologi IE5 motor.



Hot-dip galvanized tubular axial fans, with EC Technology IE5 motor with integrated electronics, specially designed for high energy efficiency.

**Fan:**

- Airflow direction from motor to impeller.
- AL version rotors made of cast aluminium.
- Support ring in sheet steel with double flange and cable glands for motor supply.
- Hot dip galvanised tubular sheet steel casing.

**EC CONTROL:** Supplied as an optional accessory. Control panel for ventilation systems with EC Technology motors with the electronics integrated in the motor itself. With the following characteristics:

- CPC: Constant pressure control.
- CFC: Constant flow control.
- DAY/NIGHT: Double pressure setpoint adjustment according to time of day.
- External sensor: compatible with temperature, humidity, air quality or CO sensor.
- Equipment preconfigured in constant pressure mode with 100 Pa set point.



EC TECHNOLOGY MOTOR with integrated electronics



EC CONTROL Supplied as an optional accessory

**Motor:**

- High efficiency EC Technology motors with integrated electronics, regulated by 0-10 V or 4-20 mA.
- IE5 efficiency motors, class F and IP55 protection.
- Single-phase 230 V 50/60 Hz and three-phase 400 V 50/60 Hz.
- Working temperature: -25 °C +60 °C.

**Finish:**

- Hot dip galvanized

**On request:**

- Airflow direction from impeller to motor.
- Fibreglass reinforced polyamide PL version impellers.
- 100% reversible impellers.

## Order code

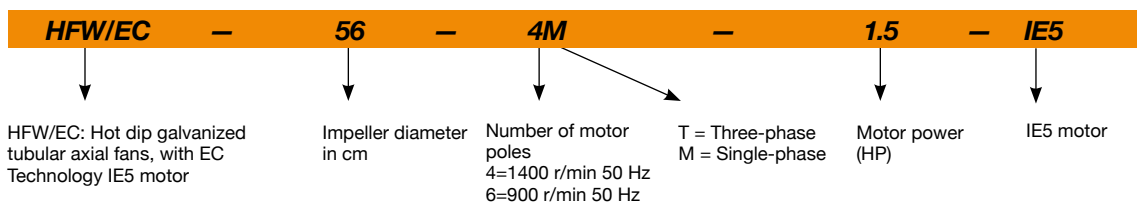

## Technical characteristics

Model	Speed (r/min)	Maximum admissible current (A)		Max. electric power (kW)	Maximum flow rate (m³/h)	Sound pressure level dB (A)	Approx. weight (Kg)	According ErP*
		230V	400V					
HFW/EC-56-4M-1.5 IE5	1455	8.9		1.1	13600	74	34	2020
HFW/EC-63-4M-1.5 IE5	1455	8.9		1.1	17800	74	36	2020
HFW/EC-63-4T-3 IE5	1435		5.9	2.2	22150	76	44	2020
HFW/EC-71-4M-1.5 IE5	1455	8.9		1.1	19500	78	39	2020
HFW/EC-71-4T-3 IE5	1435		5.9	2.2	25100	81	48	2020
HFW/EC-80-4T-3 IE5	1435		5.9	2.2	25450	82	56	2020
HFW/EC-80-4T-5.5 IE5	1450		10.6	4.0	32750	84	64	2020
HFW/EC-80-6T-3 IE5	950		7.5	2.2	29950	74	63	2020
HFW/EC-90-4T-5.5 IE5	1450		10.6	4.0	38900	89	73	2020
HFW/EC-90-6T-2 IE5	950		2.9	1.5	28800	77	67	2020
HFW/EC-90-6T-3 IE5	950		7.5	2.2	34000	78	72	2020
HFW/EC-100-6T-3 IE5	950		7.5	2.2	37600	82	80	2020

\* In accordance with the ErP 2020 draft



## Erp. (Energy Related Products)

Information on Directive 2009/125/EC can be downloaded from the SODECA website or the QuickFan selector programme.

## Acoustic characteristics

The indicated values are determined by measuring the pressure and sound power levels in dB(A) obtained in a free field at a distance equivalent to twice the size of the fan plus the impeller diameter, with a minimum of 1.5 m.

Sound power spectrum Lw(A) in dB(A) per Hz frequency band

	63	125	250	500	1000	2000	4000	8000
HFW/EC-56-4M-1.5	49	69	77	82	84	81	74	63
HFW/EC-63-4M-1.5	48	68	76	81	83	80	73	65
HFW/EC-63-4T-3	53	70	78	83	85	82	77	67
HFW/EC-71-4M-1.5	54	74	82	87	89	86	79	69
HFW/EC-71-4T-3	58	72	80	85	87	84	77	71
HFW/EC-80-4T-3	57	77	85	90	92	89	82	73
HFW/EC-80-4T-5.5	56	75	84	89	91	88	81	70
HFW/EC-80-6T-3	51	68	76	81	83	80	73	62
HFW/EC-90-4T-5.5	60	81	88	93	96	92	85	74
HFW/EC-90-6T-2	58	79	86	91	94	90	83	72
HFW/EC-90-6T-3	56	70	77	82	85	81	74	63
HFW/EC-100-6T-3	61	72	80	85	87	84	77	66

## Dimensions mm

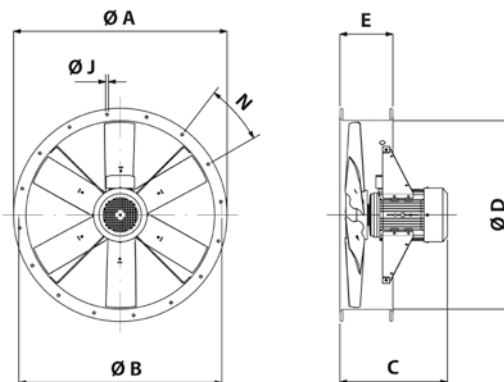

	ØA	ØB	C	ØD	E	N	ØJ
HFW/EC-56-4M-1.5	666	620	377	560	225	12X30°	12
HFW/EC-63-4M-1.5	735	690	389	640	225	12X30°	12
HFW/EC-63-4T-3	735	690	428	640	225	12X30°	12
HFW/EC-71-4M-1.5	815	770	360	710	225	12X30°	12
HFW/EC-71-4T-3	815	770	428	710	225	16x22°30'	12
HFW/EC-80-4T-3	905	860	436	800	225	16x22°30'	12
HFW/EC-80-4T-5.5	905	860	436	800	225	16x22°30'	12
HFW/EC-80-6T-3	905	860	436	800	225	16x22°30'	12
HFW/EC-90-4T-5.5	1020	970	445	900	225	16x22°30'	15
HFW/EC-90-6T-2	1020	970	445	900	225	16x22°30'	15
HFW/EC-90-6T-3	1020	970	445	900	225	16x22°30'	15
HFW/EC-100-6T-3	1118	1070	427	1000	225	16x22°30'	15

## Accessories

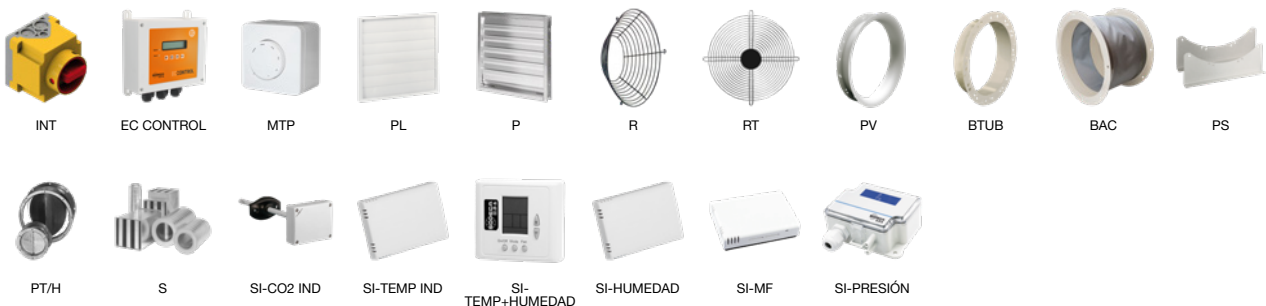

### Characteristic curves

Q= Flow rate in m<sup>3</sup>/h, m<sup>3</sup>/s and cfm Pe= Static pressure in mm H<sub>2</sub>O, Pa and inwg

**HFW/EC-56-4M-1.5**

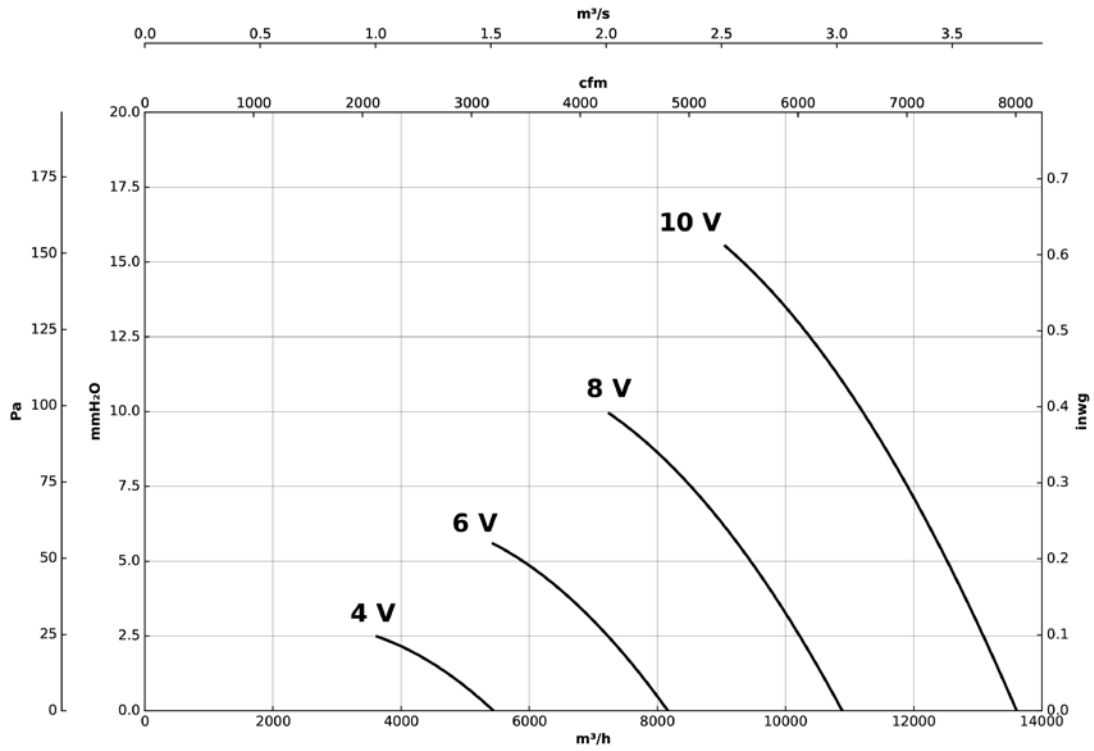

**HFW/EC-63-4M-1.5**

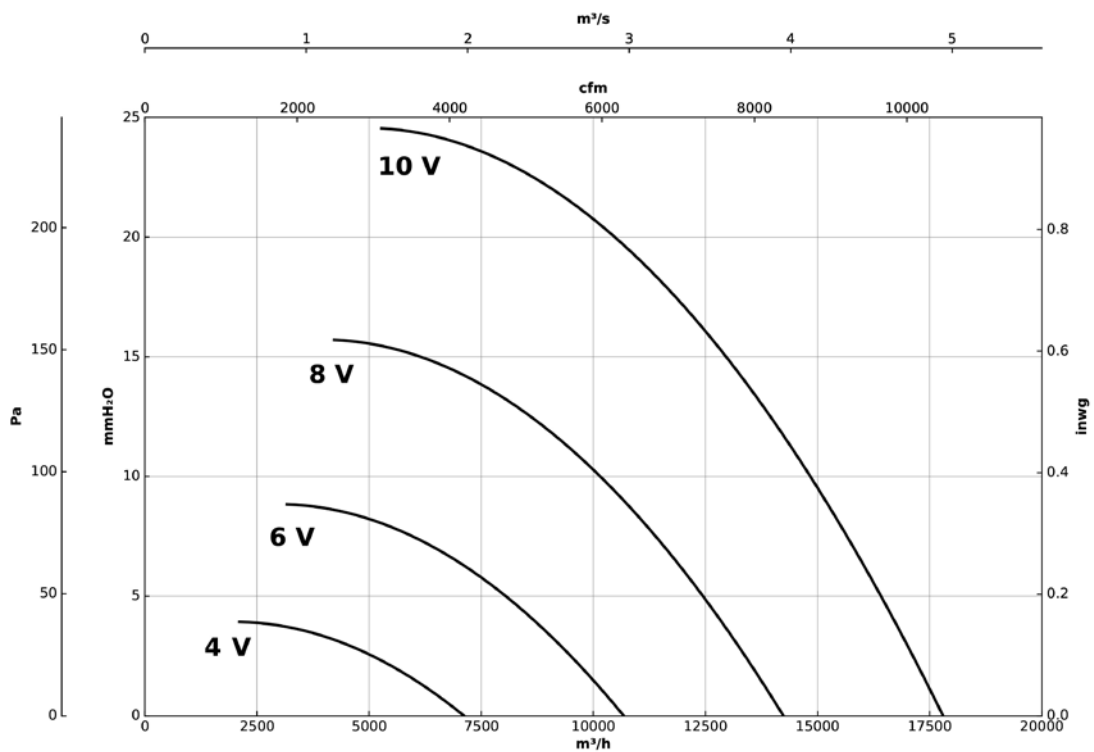



### Characteristic curves

Q= Flow rate in m<sup>3</sup>/h, m<sup>3</sup>/s and cfm

Pe= Static pressure in mm H<sub>2</sub>O, Pa and inwg

**HFW/EC-63-4T-3**

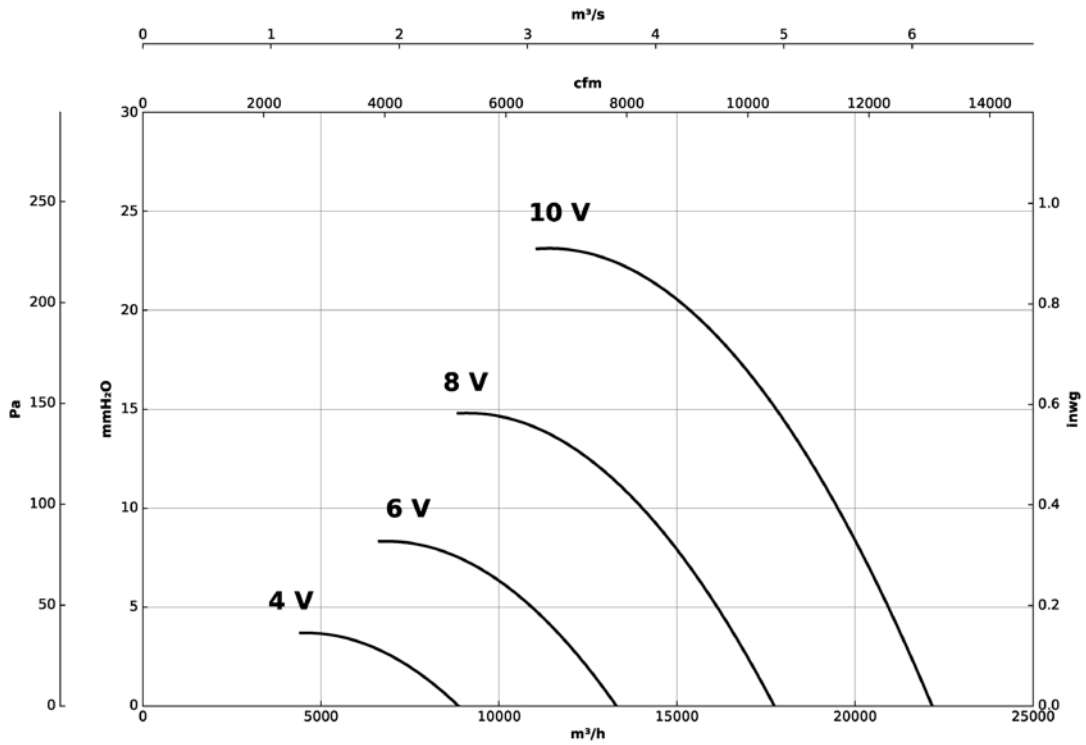

**HFW/EC-71-4M-1.5**

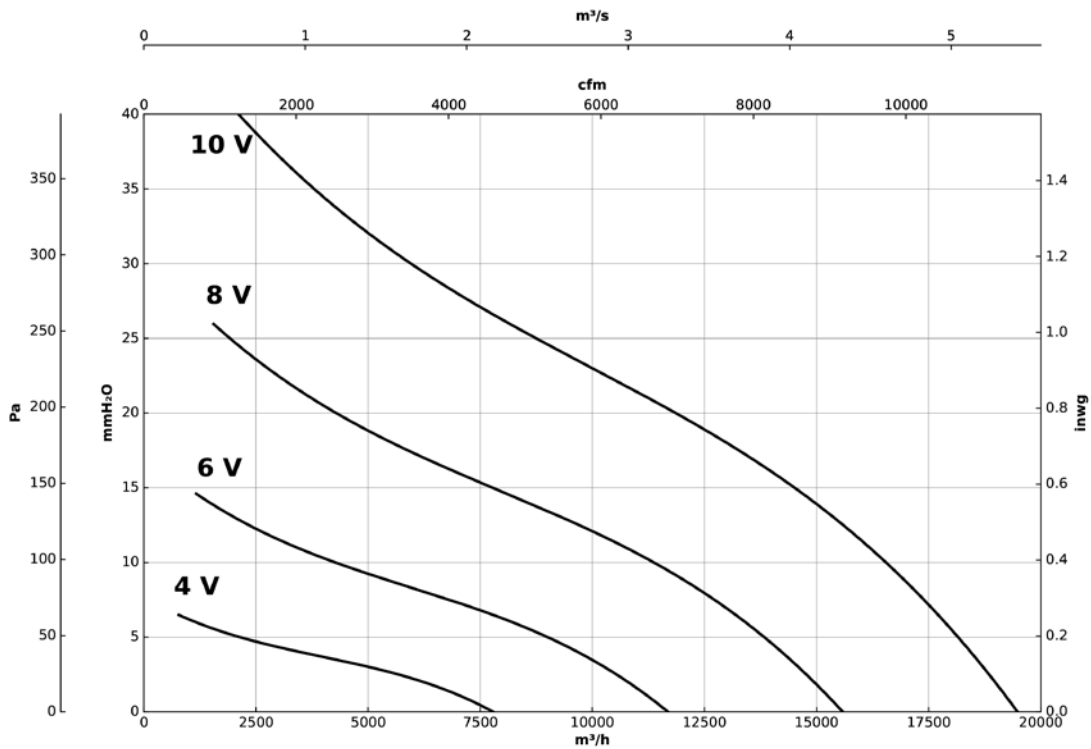

### Characteristic curves

Q= Flow rate in m<sup>3</sup>/h, m<sup>3</sup>/s and cfm      Pe= Static pressure in mm H<sub>2</sub>O, Pa and inwg

**HFW/EC-71-4T-3**

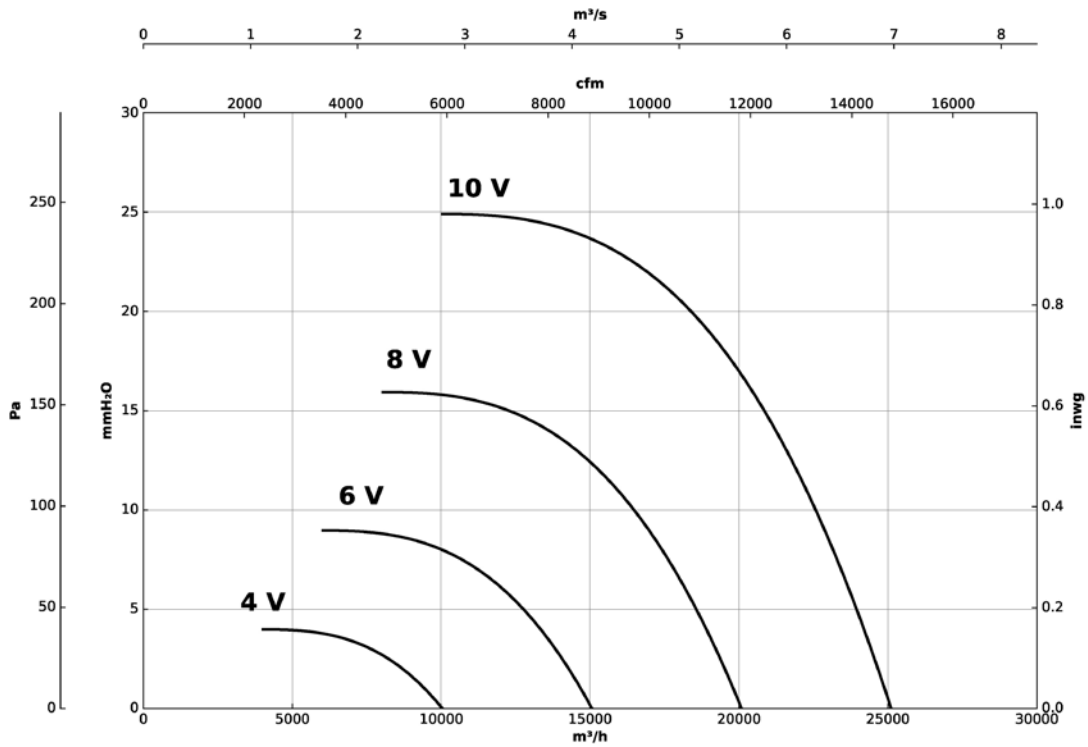

**HFW/EC-80-4T-3**

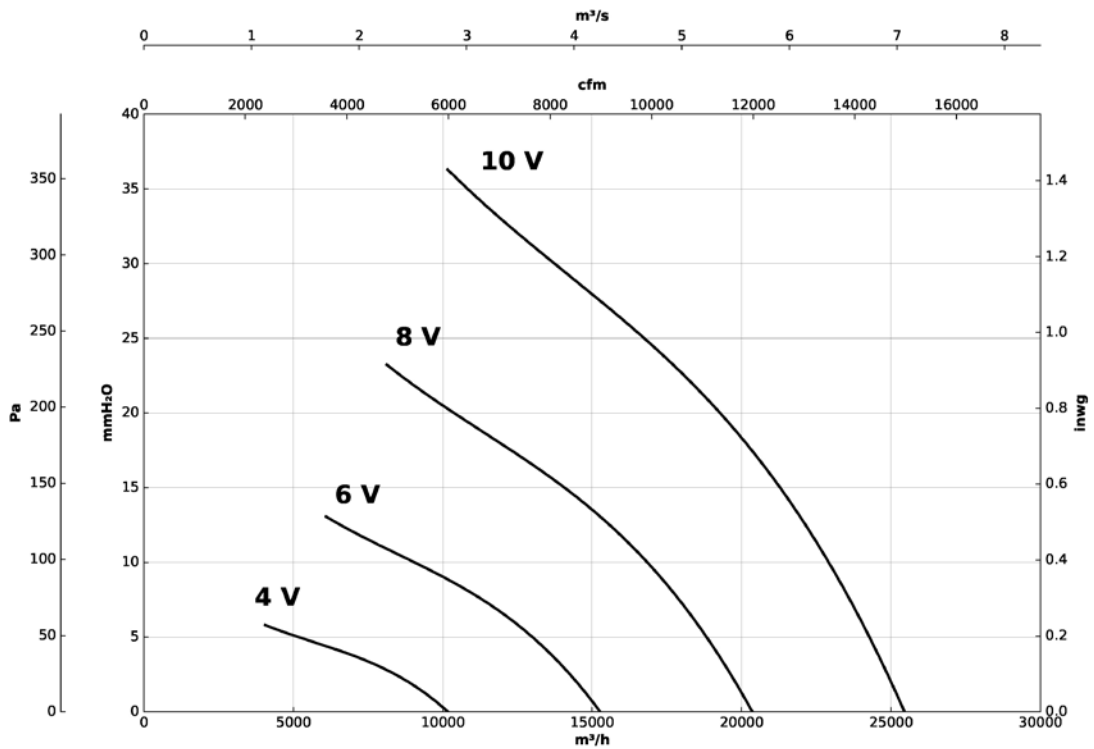



### Characteristic curves

Q= Flow rate in m<sup>3</sup>/h, m<sup>3</sup>/s and cfm

Pe= Static pressure in mm H<sub>2</sub>O, Pa and inwg

#### HFW/EC-80-4T-5.5

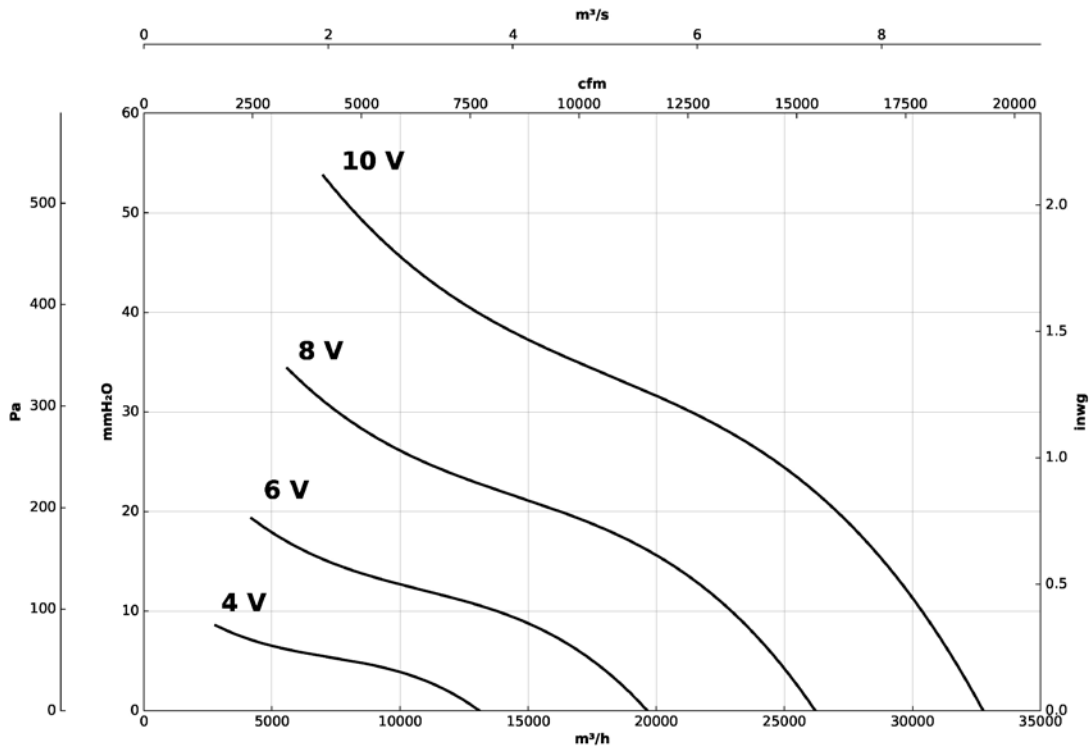

#### HFW/EC-80-6T-3

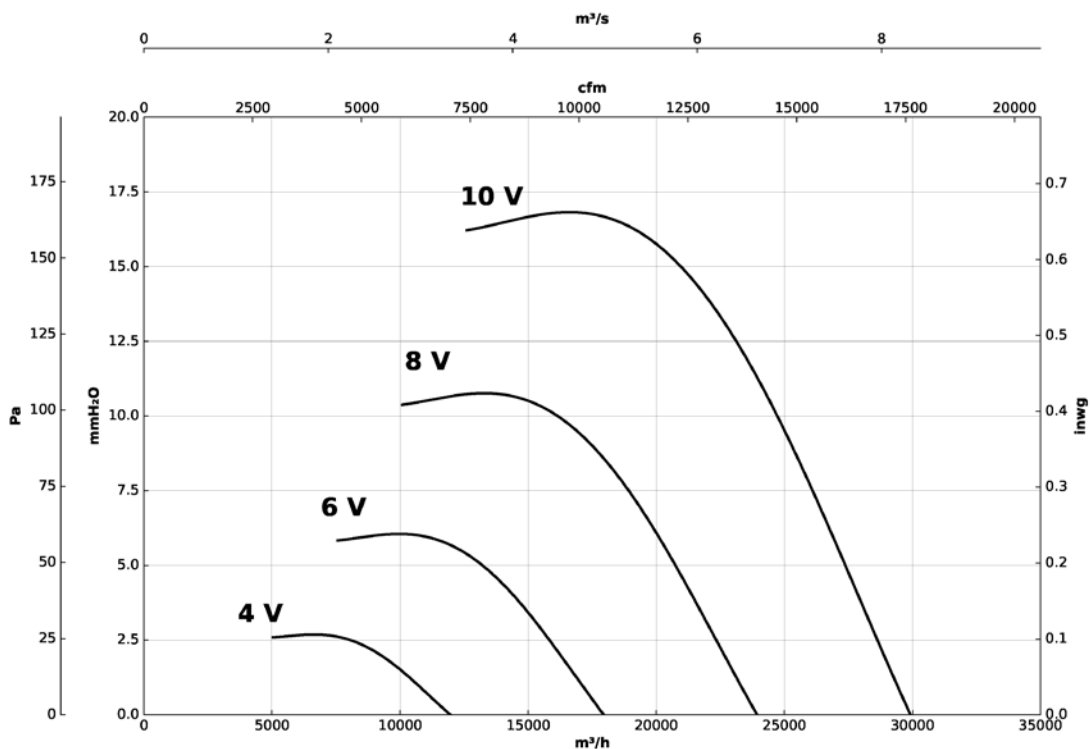

### Characteristic curves

Q= Flow rate in m<sup>3</sup>/h, m<sup>3</sup>/s and cfm      Pe= Static pressure in mm H<sub>2</sub>O, Pa and inwg

**HFW/EC-90-4T-5.5**

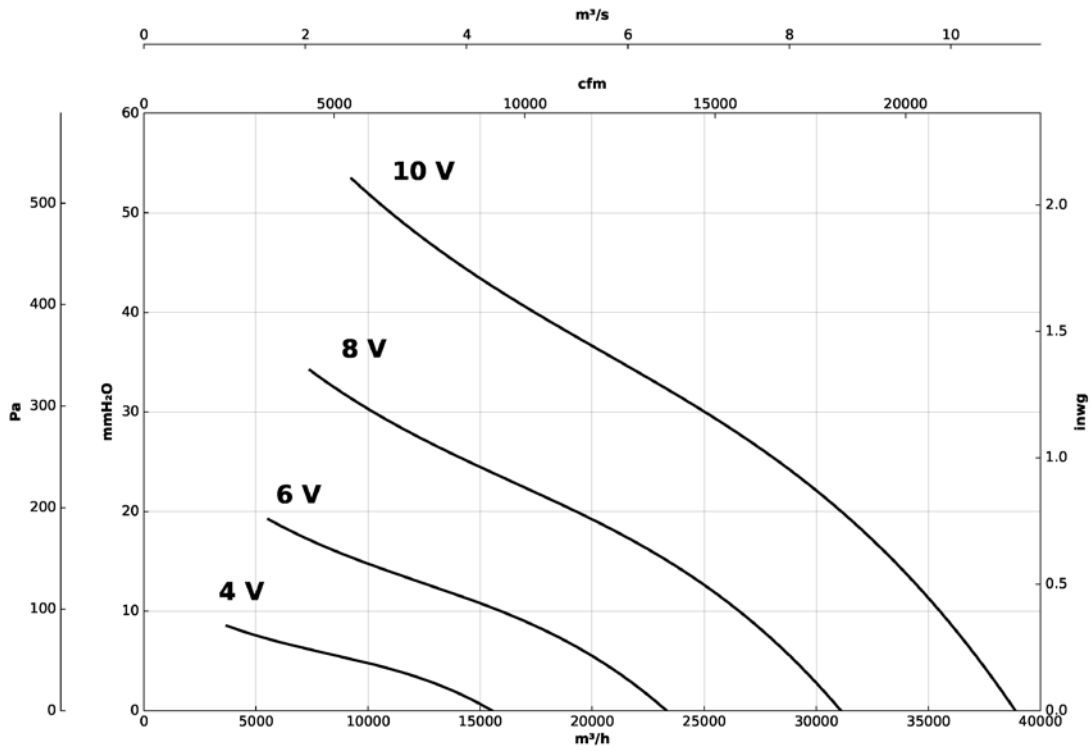

**HFW/EC-90-6T-2**

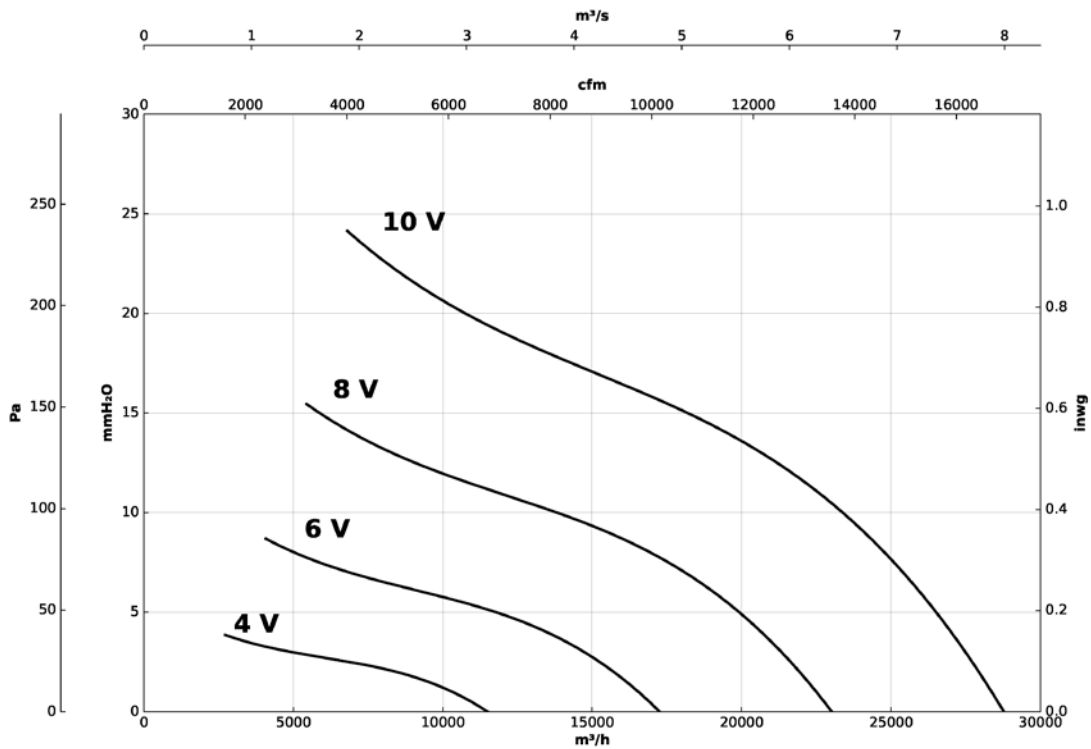



### Characteristic curves

Q= Flow rate in m<sup>3</sup>/h, m<sup>3</sup>/s and cfm

Pe= Static pressure in mm H<sub>2</sub>O, Pa and inwg

**HFW/EC-90-6T-3**

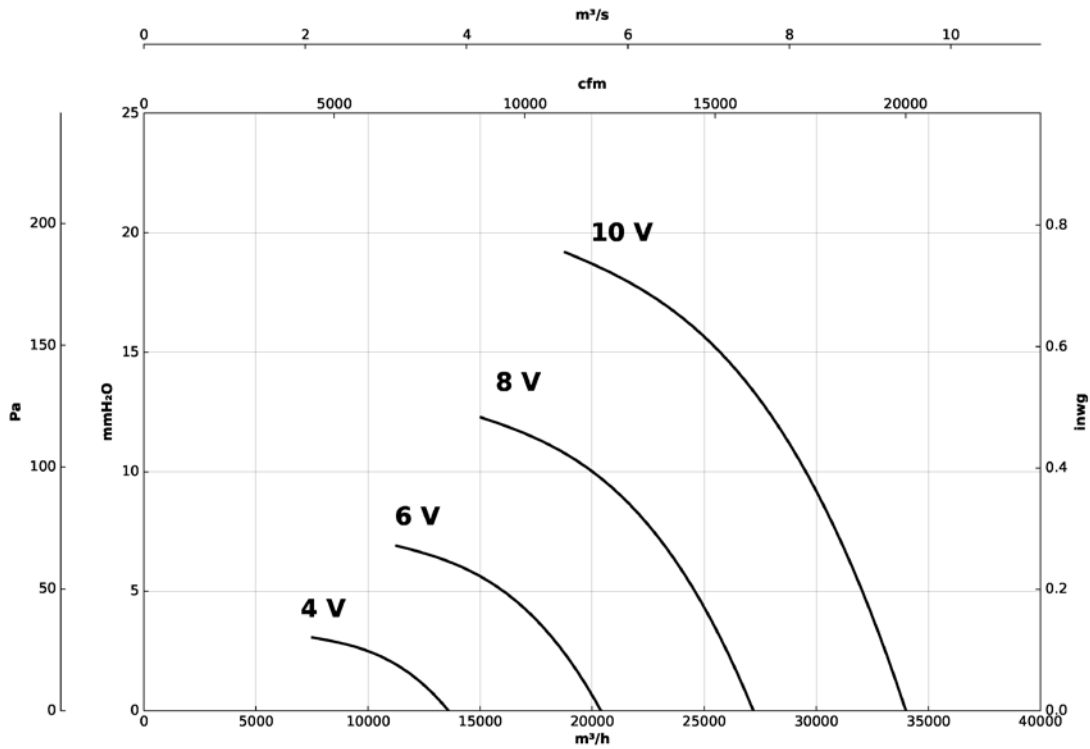

**HFW/EC-100-6T-3**

