

ROOF-MOUNTED ATEX EXTRACTOR FANS

HT/ATEX

Roof-mounted helical extractor fans with ATEX Certification and possibility of Ex e, Ex d, Ex tc and Ex tb marking

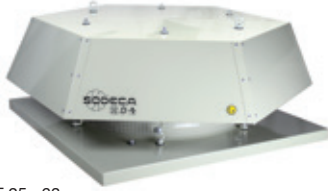

HT 25...63

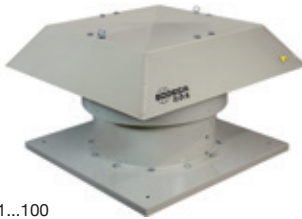

HT 71...100

Roof-mounted extractor fans with flat base and ATEX Certification, with CEE ExII2G Ex e anti-explosive, CEE ExII2G Ex d, Ex tc, or Ex tb non-sparking motor for working in explosive atmospheres containing dust or gas.

Fan:

- Support base in galvanised sheet steel with painted aluminium strip in rotor zone, in accordance with standard EN-14986
- Cast aluminium rotor
- Non-sparking cable gland included
- Anti-contact protective grille pursuant to standard UNE-EN ISO 12499
- Rain cap made of painted galvanised sheet steel, with corrosion-proof protection
- Motor-rotor airflow direction

Motor:

- Class F motors with ball bearings and ATEX Ex e explosion-proof and Ex, Ex tx or Ex tb non-sparking certification
- Three-phase 230/400V-50Hz (up to 4 kW) and 400/690V-50Hz (powers greater than 4 kW)
- Operating temperature: -20°C +40°C

Finish:

- ATEX corrosion-proof, with non-ferric paint finish of polyester resin polymerised at



Ex "e" marking: $\text{CE} \text{Ex} \text{II 2G Ex e}$
 Ex "d" marking: $\text{CE} \text{Ex} \text{II 2G Ex d}$
 Ex tc marking: $\text{CE} \text{Ex} \text{II 3D Ex tc}$
 Ex tb marking: $\text{CE} \text{Ex} \text{II 2D Ex tb}$
 Notified Body: L.O.M.
 Identification no.: LOM3ATEX0157

190°C, previously degreased with phosphate-free nanotechnological treatment

On request:

- Motors with built-in PTC
- Special windings for different voltages and frequencies
- ATEX construction for different categories
- Extractor fans with 2-speed motors
- Single-phase, Ex d non-sparking motors

Order code

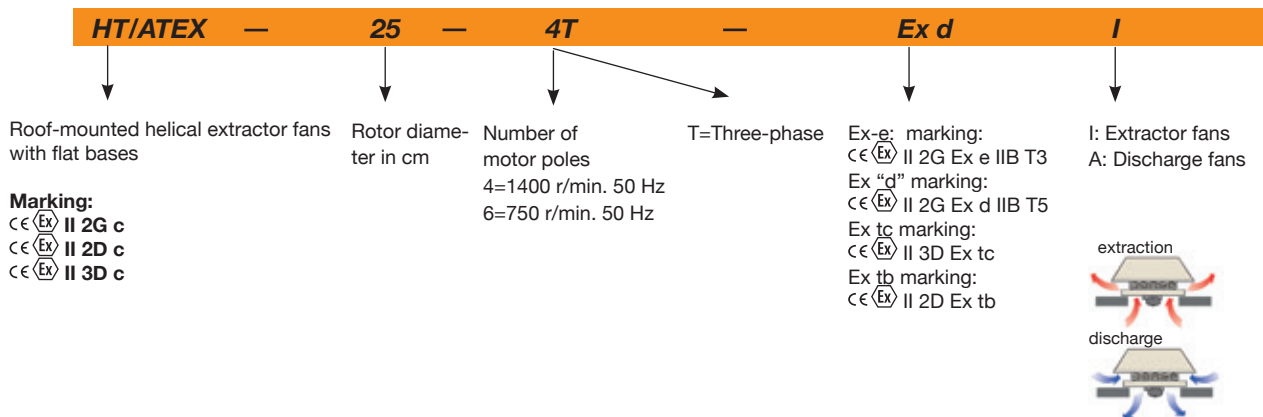

Technical characteristics

Model	Speed (r/min)	Maximum current admissible (A)			Installed power (kW)	Maximum flow rate (m ³ /h)	Sound pressure level dB(A)		Approx. weight (Kg)
		230V	400V	690V			Aspiration	Discharge	
HT/ATEX-25-4T	1320	0.65	0.38		0.09	1080	41	40	12.5
HT/ATEX-31-4T	1320	0.65	0.38		0.09	1800	47	46	13.3
HT/ATEX-35-4T	1320	0.65	0.38		0.09	2600	48	47	17.5
HT/ATEX-40-4T	1370	2.08	1.20		0.25	4600	51	50	21.0
HT/ATEX-45-4T	1370	2.60	1.50		0.37	6500	55	53	29.0
HT/ATEX-50-4T	1410	2.94	1.70		0.55	8500	59	57	36.0
HT/ATEX-56-4T	1410	3.81	2.20		0.75	9800	61	57	35.0
HT/ATEX-56-6T	910	2.42	1.40		0.25	6600	48	46	46.0
HT/ATEX-63-4T	1410	5.20	3.00		1.10	14000	63	59	65.8
HT/ATEX-63-6T	935	2.77	1.60		0.37	9200	52	49	61.8
HT/ATEX-71-4T	1400	6.93	4.00		1.50	18000	69	67	64.0
HT/ATEX-71-6T	930	3.46	2.00		0.55	12200	58	56	64.9
HT/ATEX-80-4T	1410	9.01	5.20		2.20	26200	73	70	87.8

ROOF-MOUNTED ATEX EXTRACTOR FANS

Technical characteristics

Model	Speed (r/min)	Maximum current admissible (A)			Installed power (kW)	Maximum flow rate (m³/h)	Sound pressure level dB(A)		Approx. weight (Kg)
		230V	400V	690V			Aspiration	Discharge	
HT/ATEX-80-6T	910	5.89	3.40		1.10	18000	64	61	81.8
HT/ATEX-90-4T	1440	12.30	7.10		3.00	31500	77	74	94.0
HT/ATEX-90-6T	940	7.62	4.40		1.50	21200	68	65	91.0
HT/ATEX-100-4T-7,5	1440		12.00	6.93	5.50	37000	80	77	114.0
HT/ATEX-100-4T-10	1448		16.30	9.41	7.50	44000	84	81	125.0
HT/ATEX-100-6T-2	940	7.62	4.40		1.50	25000	71	68	102.0
HT/ATEX-100-6T-3	940	9.35	5.40		2.20	28200	75	72	106.0

Acoustic characteristics

The indicated values are determined by measuring the pressure and noise level and noise level in dB(A) obtained in a free field at a distance of 6 m.

Noise power spectrum Lw(A) in dB(A) frequency band in [Hz]

Values taken during aspiration with 2/3 maximum flow rate (2/3Qmax)

Model	63	125	250	500	1000	2000	4000	8000
25	27	37	54	54	62	58	51	42
31	33	43	60	60	68	64	57	48
35	34	44	61	61	69	65	58	49
40	28	45	57	65	70	70	66	59
45	32	49	61	69	74	74	70	63
50	36	53	65	73	78	78	74	67
56-4	38	55	67	75	80	80	76	69
56-6	25	42	54	62	67	67	63	56
63-4	40	57	69	77	82	82	78	71
63-6	29	46	58	66	71	71	67	60
71-4	46	63	75	83	88	88	84	77
71-6	35	52	64	72	77	77	73	66
80-4	57	78	85	90	93	89	82	71
80-6	48	69	76	81	84	80	73	62
90-4	61	82	89	94	97	93	86	75
90-6	52	73	80	85	88	84	77	66
100-4-7.5	64	85	92	97	100	96	89	78
100-4-10	68	89	96	101	104	100	93	82
100-6-2	55	76	83	88	91	87	80	69
100-6-3	59	80	87	92	95	91	84	73

Values taken during discharge with 2/3 maximum flow rate (2/3Qmax)

Model	63	125	250	500	1000	2000	4000	8000
25	26	36	53	53	61	57	50	41
31	32	42	59	59	67	63	56	47
35	33	43	60	60	68	64	57	48
40	27	44	56	64	69	69	65	58
45	30	47	59	67	72	72	68	61
50	34	51	63	71	76	76	72	65
56-4	34	51	63	71	76	76	72	65
56-6	23	40	52	60	65	65	61	54
63-4	36	53	65	73	78	78	74	67
63-6	26	43	55	63	68	68	64	57
71-4	44	61	73	81	86	86	82	75
71-6	33	50	62	70	75	75	71	64
80-4	54	75	82	87	90	86	79	68
80-6	45	66	73	78	81	77	70	59
90-4	58	79	86	91	94	90	83	72
90-6	49	70	77	82	85	81	74	63
100-4-7.5	61	82	89	94	97	93	86	75
100-4-10	65	86	93	98	101	97	90	79
100-6-2	52	73	80	85	88	84	77	66
100-6-3	56	77	84	89	92	88	81	70

Dimensions mm

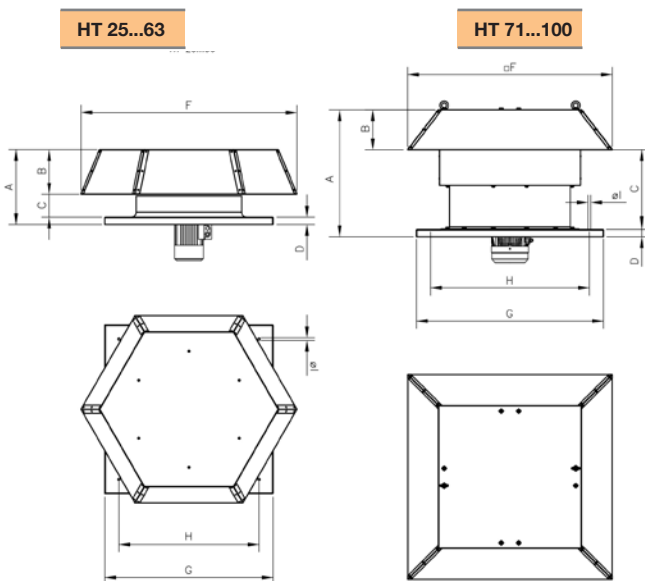

Model	A	B	C	D	F	G	H	I
HT-25	223	140	43	40	634	450	360	12
HT-31	245	140	65	40	634	500	410	12
HT-35	270	184	61	40	808	560	450	12
HT-40	295	184	86	40	808	630	530	12
HT-45	342	202	90	50	923	710	590	12
HT-50	373	238	85	50	1154	880	680	12
HT-56	402	238	124	40	1154	900	750	14
HT-63	457	277	141	40	1384	1000	850	14
HT-71	760	195	565	40	1120	1000	850	14
HT-80	790	215	575	50	1252	1150	1000	14
HT-90	910	232	678	50	1380	1150	1000	14
HT-100	1055	252	803	50	1527	1250	1100	14

ROOF-MOUNTED ATEX EXTRACTOR FANS

Characteristic curves

Q= Flow rate in m³/h, m³/s and cfm.

Pe= Static pressure in mmH₂O, Pa and inwg.

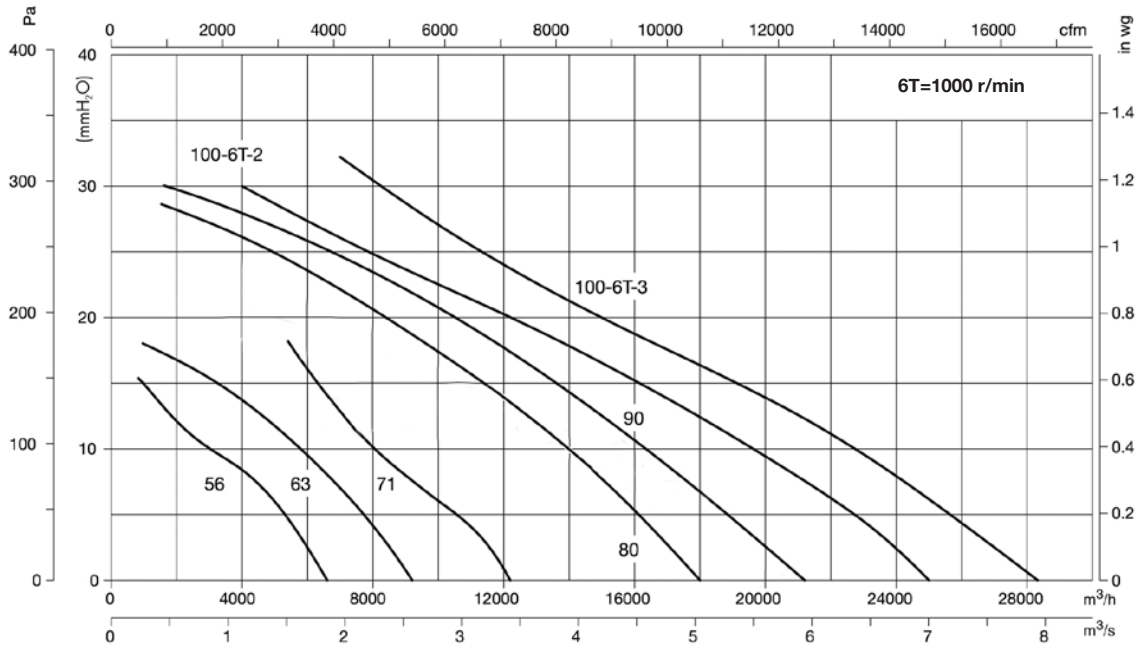
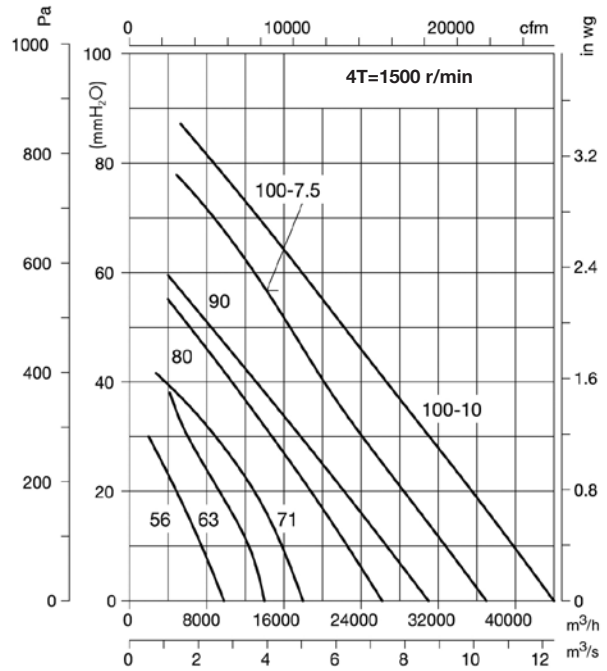
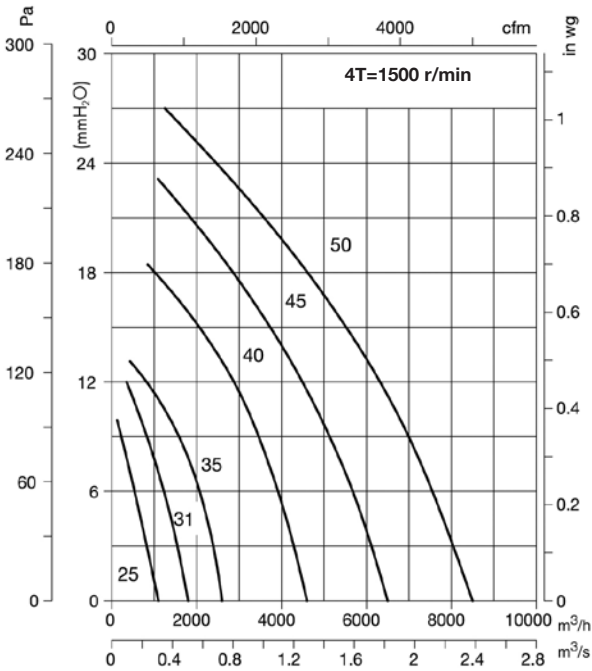

Accessories

See accessories section

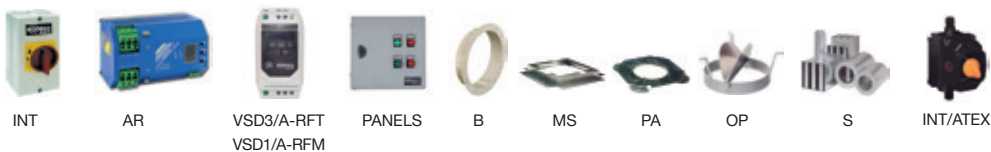

INT

AR

VSD3/A-RFT
VSD1/A-RFM

PANELS

B

MS

PA

OP

S

INT/ATEX